

Integration Guide

# S1U2



# Table of content

<b>1</b>	<b>Introduction</b>	<b>5</b>
1.1	S1U2 Payment terminal	5
1.2	Features	6
1.3	Key hardware features	6
1.4	Network considerations	6
1.4.1	Technical characteristics	7
1.4.2	Front	8
1.4.3	Rear	8
1.4.4	Bottom	8
1.4.5	Description of the interfaces	9
1.4.6	Power Management	9
1.5	Dimensions	10
1.6	Certifications	10
1.6.1	CE	10
1.6.2	Other	11
1.6.3	UKCA	11
1.6.4	RCM	11
1.6.5	FCC	11
1.6.6	IC	12
1.6.7	UL/IEC 62368-1	12
1.6.8	Detachable Antenna Usage	12
1.7	Technical characteristics	13
1.7.1	Main accessories	13
1.7.2	S1U2 software	13
1.7.2.1	General	13
1.7.3	Maintenance	13
1.7.4	Cleaning instructions	14
1.7.5	Standards	14
<b>2</b>	<b>Product installation</b>	<b>15</b>
2.1	Regulatory instructions for usage	15
2.2	Professional installation requirements	15
2.3	Packaging	15
2.4	Product rating plates	16
2.5	Select a location	16
2.6	Procedure for product installation	17
2.6.1	Package content	17
2.6.2	System requirements	17
2.6.3	Mounting instructions	17
2.6.4	EVA Mechanical standard	18
2.6.5	S1U2 product installation	20
2.6.6	Installing the all-in-one terminal	20

<b>3</b>	<b>Safety</b>	21
3.1	Operating safety	21
3.2	Safety Recommendations	21
3.2.1	Integrators	21
3.2.2	Merchants	22
3.3	EC marking	22
3.4	Repairs and end of life	22

The information provided in this documentation has been compiled with the greatest level of care. Due to further developments in the field of electronic payment transactions, as well as the technology, changes may occur that lead to deviations from these instructions. Worldline shall, therefore, accept no liability for the up-to-dateness, completeness or accuracy of the information provided in these operating instructions. Any claims for liability asserted against Worldline

which relate to instances of material or immaterial damage, which are attributable to the use or non-use of the information provided and/or the use of incorrect or incomplete information, are excluded in principle insofar as no deliberate or grossly negligent misconduct may be proven with respect to Worldline. Please contact your account manager for the most up-to-date version of this document.

# List of abbreviations

---

CVM	Cardholder Verification Method
EMC	Electro Magnetic Compatibility
EVA	European Vending Association
GND	Ground
LCD	Liquid Crystal Display
LLT	Local Loading Tool
RAM	Random Access Memory
USB	Universal Serial Bus
CL	Contactless

---

# 1 Introduction

## 1.1 S1U2 PAYMENT TERMINAL

The cutting-edge S1U2 payment terminal is designed to revolutionise the world of unattended service payments. This state-of-the-art payment solution seamlessly blends technological innovation with user-centric design, ensuring a secure, efficient and user-friendly payment experience.

At its core, the S1U2 payment terminal provides advanced hardware and software components that cater to a wide range of industries, from vending machines and parking lots to self-service kiosks and automated retail systems. Its sleek and compact shape harmonises with various environments, while its robust construction ensures durability and longevity in high-traffic settings.

The terminal's key features include:

1. Contactless Payments.
2. EMV Chip Compatibility.
3. Intuitive User Interface.
4. Real-time Connectivity.
5. Enhanced Security.
6. Customisable Branding.
7. Remote Management: The terminal's remote management capabilities enable businesses to monitor and update software, track transaction data, and perform diagnostics from a centralized platform.
8. Multi-Language Support.
9. Expandable Peripheral Integration: The S1U2 terminal can be equipped with an embedded barcode scanner, to enhance its functionality and cater to specific industry needs.
10. Its usage can be in- or outdoors, resisting to harsh weather conditions.
11. The terminals have been designed to provide a complete solution for EMV payments and can run ep2 applications from Worldline. The terminal is PCI PTS 6.x certified, SRED included.

## 1.2 FEATURES

The S1U2 offers contactless, chip and magnetic card processing. The terminal is designed to fit into any kiosk thanks to an easy surface mounting installation and complies with EVA EPS (Standard Door Module).

### Product view:



## 1.3 KEY HARDWARE FEATURES

Small footprint complies with EVA/CVS 1.3 standard for the dimensions of the Standard Door Module (SDM). The electronic parts are foreseen with a conformal coating to support you in the ATEX certification if required. Two versions have been developed to ensure the most cost-efficient solution in your environment.

4G is offered per default on both versions.

### Basic version

- Onboard Ethernet
- Serial interface
- USB C
- 4G

This version is per default equipped with 8 GB Ram/ 16 GB Flash.

### Extended version

- Onboard Ethernet
- Conformal coating
- Serial interface
- USB C
- 4G
- Scanner

In addition, the terminal is equipped with a scanner for 1D and 2D code reading. Extended memory (3 GB Ram/16 GB Flash) is foreseen to better support you with VAS/3rd party developments.

## 1.4 NETWORK CONSIDERATIONS

Worldline supports two options for connecting the S1U2 payment terminal:

- Mobile broadband (4G)
- Onboard ethernet interface supporting fixed broadband

Please note that Worldline has no control over and can't be held responsible for the quality of network solutions.

Worldline will not support (or parameterise) hybrid solutions, such as the use of mobile broadband routers/modems behind

the ethernet interface as there is too much dependency on the quality provided by the mobile operator, which is often affected by indoor signal reception issues or faraday cage of the device.

For use of the 4G network an external antenna needs to be used. The antenna needs to have an SMB connector and can optionally be supplied by Worldline as an accessory. Please check chapter with accessories (1.8.1).

## 1.4.1 TECHNICAL CHARACTERISTICS

	Basic	Premium
<b>Processor</b>	Crypto: ARM Cortex M3, 250 MHz Application: Qualcomm Cortex A53 Quad-Cor, 1.3 GHz	Crypto: ARM Cortex M3, 250 MHz Application: Qualcomm Cortex A53 Quad-Cor, 1.3 GHz
<b>Memory</b>	2 GB RAM/16 GB Flash	3 GB RAM/32 GB Flash
<b>OS</b>	Android 10	Android 10
<b>Display</b>	5" capacitive touch TFT LCD with Capacitive Touch Panel with 1280 × 720 Pixels 800NITS brightness backlight	5" capacitive touch TFT LCD with Capacitive Touch Panel with 1280 × 720 Pixels 800NITS brightness backlight
<b>Keypad</b>	No physical keypad – Touchscreen	No physical keypad – Touchscreen
<b>Card reader</b>	Separated card readers Magstripe/Chip/NFC	Separated card readers Magstripe/Chip/NFC
<b>Communication</b>	<ul style="list-style-type: none"> <li>• RS232, USB</li> <li>• Ethernet</li> <li>• Wi-Fi BT</li> <li>• 4G</li> </ul>	<ul style="list-style-type: none"> <li>• RS232, USB</li> <li>• Ethernet</li> <li>• Wi-Fi BT</li> <li>• 4G</li> </ul>
<b>Power supply</b>	External, not included Input: 9–48V DC	External, not included Input: 9–48V DC
<b>Dimensions L × W × H</b>	55.5 × 110.15 × 168 mm	55.5 × 110.15 × 168 mm
<b>Required space L × W</b>	Cut-out of EVA dimensions 110 × 146 mm	Cut-out of EVA dimensions 110 × 146 mm
<b>Weight</b>	709 g	709 g
<b>PCI version</b>	PCI PTS 6.x	PCI PTS 6.x
<b>Ambient conditions</b>	Operating: –20 °C to 65 °C Humidity: 5% to 90% non-condensing Storage: –35 °C to 70 °C	Operating: –20 °C to 65 °C Humidity: 5% to 90% non-condensing Storage: –35 °C to 70 °C
<b>Water/Dust-proof</b>	IP65 (front only)	IP65 (front only)
<b>Impact resistance</b>	IK10 (front only)	IK10 (front only)
<b>Cash register connection</b>	TIM API	TIM API
<b>Other</b>	–	Conformal coating – ATEX Barcode scanner

## 1.4.2 FRONT



- ❶ Power LED
- ❷ Contactless Card Landing Zone/LCD Display
- ❸ Chip Card Reader
- ❹ Magnetic Stripe Reader
- ❺ Front Camera
- ❻ NFC
- ❼ Aiming LED

## 1.4.3 REAR

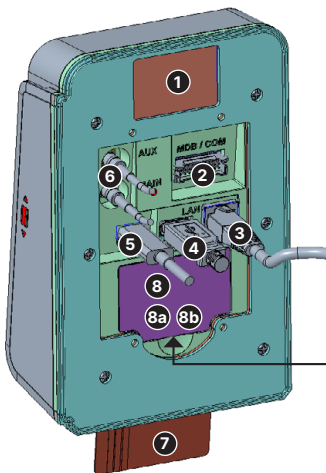

- ❶ Product label
  - ❷ Serial
  - ❸ Ethernet Port
  - ❹ USB Type A Slot (5Vdc, 0.5A max.)
  - ❺ USB Type C Slot (5Vdc, 0.5A max.)
- Important note: USB Type A Slot + USB Type C Slot: 0.5A max.**
- ❻ Antenna Slot/4G antenna connector
  - ❼ Chip Card Reader (CCR)
  - ❽ Cover to access SIM and SAM slots
  - ❽a GSM Micro SIM Card Slots
  - ❽b SAM Card Slots

## 1.4.4 BOTTOM



- ❶ Aiming LED (\*)
  - ❷ Barcode/QR scanner (\*)
  - ❸ Speaker
  - ❹ Chip
- (\*) Only available in the extended version.



### 1.4.5 DESCRIPTION OF THE INTERFACES

#### USB device

- 2 USB onboard interfaces
- The device uses type A and C USB connections.
- Cable length should not exceed 5 m.

#### RS232 interfaces

- The device is equipped with 2 serial interfaces via the add-on cable.
- The connector type is RJ45

PIN No	Function
1	GND
2	Wake-up
3	RXD
4	TXD
5	CTS
6	RTS

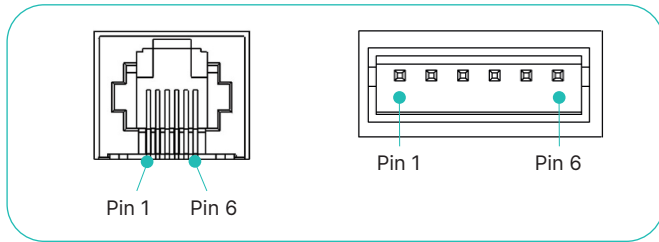

#### SIM & SAM Installation

1. Disconnect the device from cable power supply.
2. Remove the black plastic part at the bottom/back of the terminal (SAM1, SAM2 & SIM1, SIM2 card slots become visible).
3. Insert the SAM cards in SAM slot 1 and/or slot 2. Take care with regard to the corner. angle location. Direction and orientation for card insertion are printed next to the slots.
4. Place the black plastic part at its original position.

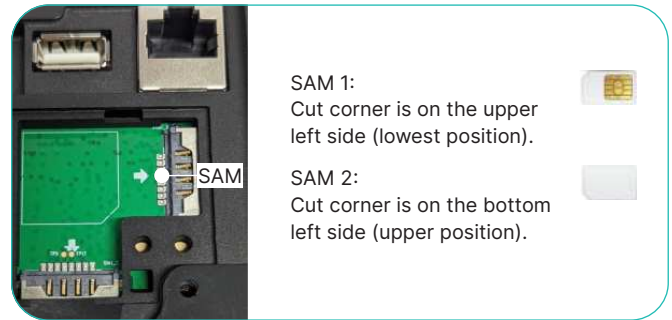

SAM 1:  
Cut corner is on the upper left side (lowest position).

SAM 2:  
Cut corner is on the bottom left side (upper position).

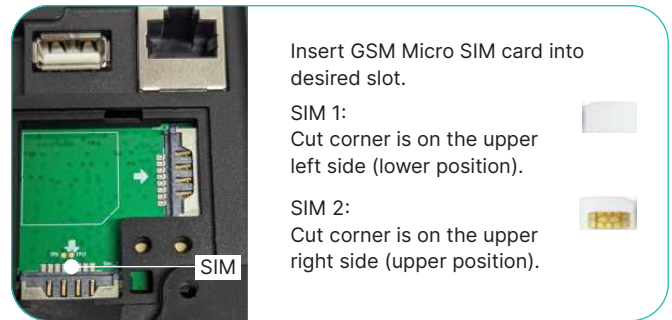

Insert GSM Micro SIM card into desired slot.

SIM 1:  
Cut corner is on the upper left side (lower position).

SIM 2:  
Cut corner is on the upper right side (upper position).



#### Speaker

The speaker is controlled by the payment application.

#### Card entry

Card entry information (guidance) can be displayed on the screen.

#### Keyboard

There is no keyboard, the terminal is equipped with a capacitive touch screen.

#### LED

The device has a visible power LED at the front (up right position).

### 1.4.6 POWER MANAGEMENT

There is no wake-up function available on the terminal to support power management. Please consider when installing the terminal that a permanent power source is available.

## 1.5 DIMENSIONS



Product dimensions are L × W × H: 55.5 × 110.15 × 168 mm.

## 1.6 CERTIFICATIONS

### 1.6.1 CE

Operations in the 5.15–5.35 GHz band are restricted to indoor usage only.

#### 1. Safety

IEC 62368-1:2014  
IEC 62368-1:2018  
EN IEC 62368-1:2020+A11:2020

#### 2. Electromagnetic compatibility

EN 55032:2015+A11:2020  
EN 55035:2017+A11:2020  
EN 301489-1 v2.2.3:2019-11  
EN 301489-3 v2.1.1:2019-03  
EN 301489-17 v3.2.4:2020-09  
EN 301489-19 v2.1.1:2019-04  
EN 301489-52 v1.2.1:2021-11  
EN 61000-3-2:2019+A1:2021  
EN 61000-3-3:2013+A1:2019+A2:2021+AC:2022-01  
EN 61000-4-2:2009  
EN 61000-4-3:2020  
EN 61000-4-4:2012  
EN 61000-4-5:2014+A1:2017  
EN 61000-4-6:2014+AC:2015

## 1.6.2 OTHER

EN IEC 62368-1:2020 + A11:2020  
IEC 62368-1:2014  
IEC 62368-1:2018

## 1.6.3 UKCA

### 1. Safety

BS EN 62368-1:2014+A11:2017  
BS EN IEC 62368-1:2020+A11:2020

### 2. Electromagnetic compatibility

BS EN 55032:2015+A11:2020  
BS EN 55035:2017+A11:2020  
BS EN 301489-1 v2.2.3:2019-11  
BS EN 301489-3 v2.1.1:2019-03  
BS EN 301489-17 v3.2.4:2020-09  
BS EN 301489-19 v2.1.1:2019-04  
BS EN 301489-52 v1.2.1:2021-11  
BS EN 61000-3-2:2019+A1:2021  
BS EN 61000-3-3:2013+A1:2019+A2:2021+AC:2022-01  
BS EN 61000-4-2:2009  
BS EN 61000-4-3:2020  
BS EN 61000-4-4:2012  
BS EN 61000-4-5:2014+A1:2017  
BS EN 61000-4-6:2014+AC:2015  
BS EN 61000-4-8:2009  
BS EN 61000-4-11:2020+AC:2020-06

## 1.6.4 RCM

### Missing info



(RCM regulation does not explicitly require specific descriptions or warnings to be included in the product manual. Here, the logo can be placed in the product manual. The RCM logo regulation is required to be larger than 3 mm height.)

## 1.6.5 FCC

### Federal Communication Commission Interference Statement

This device complies with Part 15 of the FCC Rules. Operation is subject to the following two conditions:

1. This device may not cause harmful interference, and
2. this device must accept any interference received, including interference that may cause undesired operation.

This equipment has been tested and found to comply with the limits for a Class B digital device, pursuant to Part 15 of the FCC rules. These limits are designed to provide reasonable protection against harmful interference in a residential installation. This equipment generates, uses and can radiate radio frequency energy and, if not installed and used in accordance with the instructions, may cause harmful interference to radio communications. However, there is no guarantee that interference will not occur in a particular installation. If this equipment does cause harmful interference to radio or television reception, which can be determined

by turning the equipment off and on, the user is encouraged to try to correct the interference by one of the following measures:

- Reorient or relocate the receiving antenna.
- Increase the separation between the equipment and receiver.
- Connect the equipment into an outlet on a circuit different from that to which the receiver is connected.
- Consult the dealer or an experienced radio/TV technician for help.

### FCC Caution:

- Any changes or modifications not expressly approved by the party responsible for compliance could void the user's authority to operate this equipment.
- This transmitter must not be co-located or operating in conjunction with any other antenna or transmitter.

### Radiation Exposure Statement

This equipment complies with FCC radiation exposure limits set forth for an uncontrolled environment. This equipment should be installed and operated with a minimum distance 20 cm between the radiator & your body.

**Note:** The country code selection is for non-US model only and is not available to all US model. Per FCC regulation, all

Wi-Fi product marketed in US must fixed to US operation channels only.

Operation in the band 5150-5250 MHz is only for indoor use to reduce the potential for harmful interference to co-channel mobile satellite systems.

## 1.6.6 IC

### Industry Canada statement

This device complies with ISED's license-exempt RSSs. Operation is subject to the following two conditions:  
1. This device may not cause harmful interference, and  
2. this device must accept any interference received, including interference that may cause undesired operation.

### Radiation Exposure Statement:

This equipment complies with ISED radiation exposure limits set forth for an uncontrolled environment. This equipment should be installed and operated with greater than 20 cm between the radiator & your body.

### Warning:

The equipment is only suitable for wall mounting at a height  $\leq 2$  m.

## 1.6.7 UL/IEC 62368-1

### Warning:

- Power cord shall be connected to a socket-outlet with earthing connection.
- Risk of explosion if battery is replaced by an incorrect type. Dispose of used battery in accordance with local disposal regulations.

- This product is intended to be supplied by a Listed Power Adapter or DC power source marked "L.P.S." (or "Limited Power Source"), rated 9-48 V DC, 1.5-0.5 A minimum, Tma = 40 degree C minimum.

The equipment is only suitable for wall mounting at a height  $\leq 2$  m.

## 1.6.8 DETACHABLE ANTENNA USAGE

This radio transmitter [IC: 27350-S1U2001] has been approved by Innovation, Science and Economic Development Canada to operate with the antenna types listed below, with the maximum permissible gain indicated. Antenna

types not included in this list that have a gain greater than the maximum gain indicated for any type listed are strictly prohibited for use with this device.

Manufacturer Model Antenna Type Max Gain (dBi) Impedance ( $\Omega$ )

Manufacturer	Model	Antenna Type	Max Gain (dBi)	Impedance ( $\Omega$ )
ADVANCED WIRELESS & ANTENNA INC	WWAN	Dipole Antenna for LTE application	2.66 dBi	50 ohm
ADVANCED WIRELESS & ANTENNA INC	WLAN PIFA	Antenna for Wi-Fi application	4.427 dBi	50 ohm
SPORTON INTERNATIONAL INC	NFC	Loop antenna	N/A	50 ohm

### Note:

To ensure waterproofness the S1U2 terminal installed in vending machines, parking, kiosks or gas stations requires a roof-mounted antenna.

## 1.7 TECHNICAL CHARACTERISTICS

Mass	709 g
Dimensions L × W × H	55.5 × 110.15 × 168 mm
Power supply	48 V External power supply (via molex): 9–48 V DC
Platform	Android 10
Memory	Basic version: 2 GB/16 GB Extended version: 3 GB/32 GB Note that memory is not upgradable after production

### 1.7.1 MAIN ACCESSORIES

For a complete description of the supported accessories, please refer to the order list of this product.

### 1.7.2 S1U2 SOFTWARE

The S1U2 comes with the Worldline ep2 software. More details on its functioning can be downloaded from SCS.

#### 1.7.2.1 GENERAL

S1U2 is a secure payment device built around on Android 10.

### 1.7.3 MAINTENANCE

There is no physical maintenance button on the terminal, to enter the maintenance mode.

- Maintenance mode is only supported for our partners.
- Further instruction on the software setup can be found in the Configuration Guide available on SCS.

#### Configuration

The device delivered to you has a minimum operating configuration loaded.

The software and the files for defining the parameters are installed in the factory. To change the configuration, you can load the latest software from the SCS. For more information on configuration, please contact your technical support team.

#### Operating life

The device has MTBF 50,000 hours. Failure rate during the first 3 years is expected to be around 10%.

## 1.7.4 CLEANING INSTRUCTIONS

The external front of the contactless reader should be carefully cleaned on a regular basis. The aim is to keep the display free of dirt and solvents. During this process, first disconnect all cables from the terminal.

- Use a soft cloth slightly soaked in soapy water to clean the outside of the terminal.
- The glass has a special surface treatment, thus it must be cleaned carefully.
- Do not clean the electrical components.
- Never use solvents, detergents or abrasive cleaners. These materials could damage the plastic or the electrical parts.

- Avoid the use of pressurised liquids.
- Do not expose the terminal to direct sunlight.

Do not clean the plastics with any type of alcohol. The display can be cleaned with ethanol alcohol. Be sure that no liquid is entered under the plastics. Cleaning with alcohol should only be required when screen-protective films are being used.

## 1.7.5 STANDARDS

### Electrical consumptions

- Max power supply: 48 V
- Backup battery life: 5 years of storage (depending on environmental conditions)

### Temperature and humidity

Operating and storage conditions:

- 709 g Environment
- Operating Temperature  $-20^{\circ}\text{C}$  to  $65^{\circ}\text{C}$
- Storage Temperature  $-35^{\circ}\text{C}$  to  $70^{\circ}\text{C}$  operating
- Humidity 5% to 90% non-condensing
- Storage Humidity 5% to 90% non-condensing

Operating conditions:

- Relative humidity: 5% to 90% non-condensing at  $65^{\circ}\text{C}$
- External temperature range:  $-20^{\circ}\text{C}$  to  $+65^{\circ}\text{C}$

Storage conditions:

- 5% to 90% non-condensing at  $70^{\circ}\text{C}$
- External temperature range:  $-35^{\circ}\text{C}$  to  $+70^{\circ}\text{C}$

### Environmental specifications continued

- Front face shock resistance: IK10
- Vibrations resistance: NF EN 60068-2-6 and the below conditions (10 tests sequences per axis):
  - From 5 Hz to 9 Hz with 3,3 mm amplitude
  - From 9 Hz to 200 Hz with  $10\text{m/s}^2$  acceleration
  - From 200 Hz to 500 Hz with  $15\text{m/s}^2$  acceleration
- Endurance 30 mn on each resonance frequency
- Bumps resistance: NF EN 60068-2-29. E
  - Each direction, 500 drops  $1/2$  sinus 25 g – 6 ms

Natural events:

- Water and dust resistant IP65 (S1U2 front face only).

Degradation specification:

- Vandal resistant: IK10
- Certified anti-tamper and attack resistant
- Drop:  $-0.8$  m on concrete

## 2 Product installation

This document provides a guideline for operating and configuring Castles S1U2 terminal. The scope of this document includes setting up the terminal, basic operation, application lifecycle, and some advanced features.

### 2.1 REGULATORY INSTRUCTIONS FOR USAGE

Before using the terminal, please check if it has been disassembled, modified or if it shows any abnormalities. If yes, please do not use.

- Please stay away from strong electromagnetic waves. (Example) Microwave ovens, magnets, shoplifting prevention devices, high-voltage wires, automatic doors, communication antennas, etc.
- Condensation can occur when moving from a cold place to a warm place. If condensation occurs, do not use the unit until the connected water droplets evaporate.
- Static electricity may occur in some places (such as where you use a carpet).
- Please do not leave it in the sun for a long time.
- Please operate the unit carefully as it is a precision instrument. Do not apply impact, do not drop or do not put heavy objects on top of the terminal.
- Do not attach dust, oil, etc. to a part of the power terminal. Also, do not scratch.

### 2.2 PROFESSIONAL INSTALLATION REQUIREMENTS

Worldline only sells its products to qualified partners and integrators. These are responsible for the professional resale, integration and installation of these products into complete solutions for retailers. These solutions can be:

- Petrol stations
- Ticketing kiosks (Airline tickets, cinema, transport, etc.)
- Vending machines
- Parking kiosks (On-/off-street)
- Others

Partners, resellers, and integrators must have qualified electronics engineers to be able to install or integrate our products.

In addition, installation must be carried out in accordance with Worldline's recommendations as described in this document and in compliance with local regulations for electrical safety and radio emission levels.

Our on-site support and maintenance engineers are available to follow up and commission the installation towards integrators.

### 2.3 PACKAGING

The complete bill of material must be checked on receipt. It contains the following:

- 1 terminal
- 1 fixing plate
- 1 gasket
- Bolts and nuts
- I/O cable

In case of doubt or if items are missing or damaged, contact your shipping company and/or vendor.

If you want to attach the mounting plate directly to the vending machine, you will also need four M4 locknuts and washers. These are not included in the packaging.

## 2.4 PRODUCT RATING PLATES

A rating plate on a machine carries technical information. The plate contains the names of the machine, as well as other technical specifications of the terminal. Both the terminal and the packaging contain a rating plate with more information on the device.

Examples of product rating plates are provided to show what information is given on each plate. Minor differences in layout may occur.

Box:

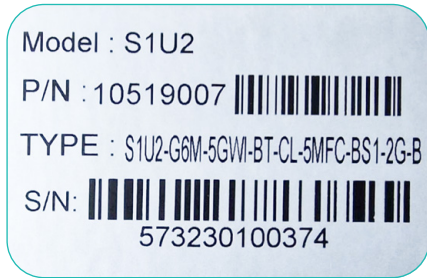

Terminal:

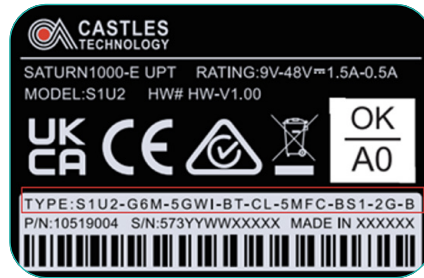

Explanation of the terminal type information:

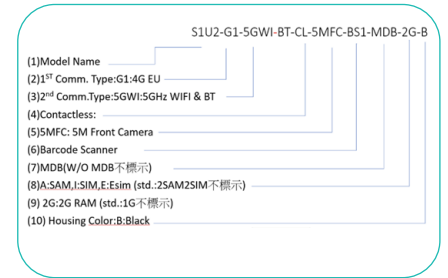

## 2.5 SELECT A LOCATION

The terminals are designed for unattended usage both in- and outdoors. Electrical installations where the S1U2 terminals are installed, must comply with local and regional codes for office and residential electrical wiring such as International Electrotechnical Commission (IEC).

Finding a proper location is an important aspect for installing the S1U2 terminal.

Please follow the guidelines listed here and also check the local requirements:

- Select a location on the machine that is conveniently accessible on the front side.
  - Make sure that:
    - The S1U2 terminal fit in the mounting position
    - The display faces the cardholder and is clearly visible
    - The display is readable
    - The card slots are accessible, please check chapter with the mounting instructions
- Make sure there is sufficient space in the vending machine to:
  - Fit the mounting brace that fastens the terminal tightly into the machine
  - Access the ground connection
  - Guide the cables without folding them and use cable ties
  - The maximum permitted length of the cable between the S1U2 and the vending machine controller (VMC) is max 3 m
- Avoid a position that exposes the card reader to rain or hostile weather.
- Always mount the S1U2 terminals vertically
- Make sure air can circulate freely around the components.
- Take additional measures to avoid condensation or humidity inside the vending machine or in other locations where the S1U2 is integrated. Installing moderate levels of heating and/or ventilation can help, as can leaving the terminal active at all times.

- To avoid reflections and to guarantee readability, do not expose the display to direct sunlight.
- For the security of the cardholder, make sure that PIN privacy is guaranteed.
- Locate the display outside the field of vision of cameras, mirrors and away from stairs.
- Check all local regulations and requirements for PIN privacy. There is information about this topic in the S1U2 Security Policy, available on the PCI website.

**Important note:** It is required to use ESD protective clothing while handling these devices.

The S1U2 is compliant with the current applicable PCI PTS security requirements. Upon receipt of your terminal, you should check for signs of tampering of the equipment. It is strongly advised that these checks are performed regularly after receipt. You should check, for example: That the reader is firmly in place; that there is no evidence of unusual wires that have been connected to any ports on your terminal or associated equipment, the chip card reader or any other part of your terminal.

- You are strongly advised to ensure that privileged access to your terminal stock is only granted to staff that has been independently verified as being trustworthy.
- The terminal must never be put in or left at a location where it could be stolen or replaced by another device.
- You are strongly advised to perform regular checks on the chip card reader.
- Such checks are crucial to learn about any unauthorised modifications to your terminal and other suspicious behaviour by people who have access to the device. Your terminal can detect any "tampered state". In this state, the terminal repeatedly flashes the message "Alert Irruption!" and further use of the terminal is not possible. If you observe a tamper state message, you should contact the terminal helpdesk immediately.



## 2.6 PROCEDURE FOR PRODUCT INSTALLATION

### 2.6.1 PACKAGE CONTENT

Upon receipt of your order, please check that the box is received without any damage. Check also unusual wiring, if such is the case, do not install the terminal and return it to Worldline.

- S1U2 Unattended Payment Terminal
- Mounting Hardware
- Add-on cable with MDB moxex plug and 2 serial interfaces/IO cable

- Power adaptor, DC jack conversion- and LAN cables are accessories and should be ordered separately.

### 2.6.2 SYSTEM REQUIREMENTS

- Worldline configuration instruction containing
  - a valid Terminal identifier (TID)
  - a valid Worldline merchant account. (merchant ID)
  - terminal password
- A stable and reliable internet connection.
- Power outlet for the payment terminal.

### 2.6.3 MOUNTING INSTRUCTIONS

The terminal needs to be surface mounted in a vertical position. It complies with the EVA standard using a mounting plate to be positioned at the inside of the machine.

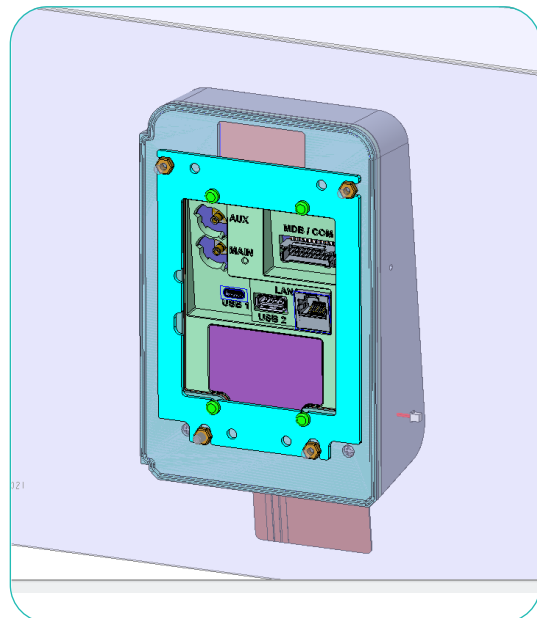
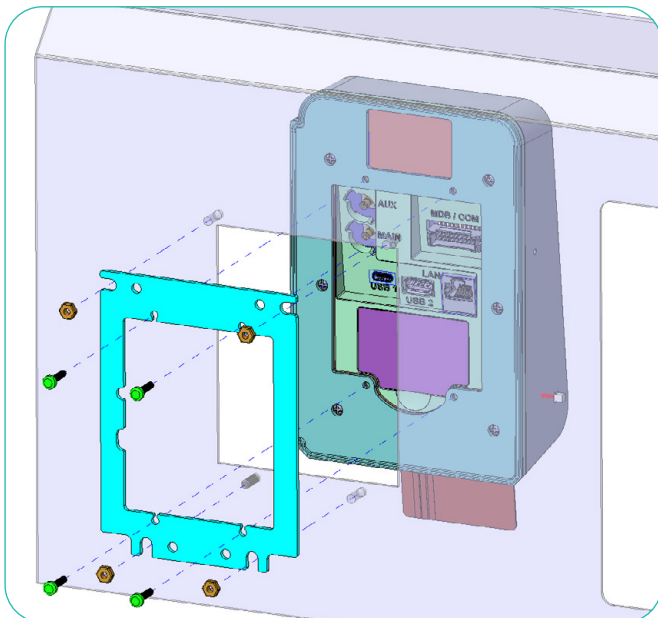

## 2.6.4 EVA MECHANICAL STANDARD

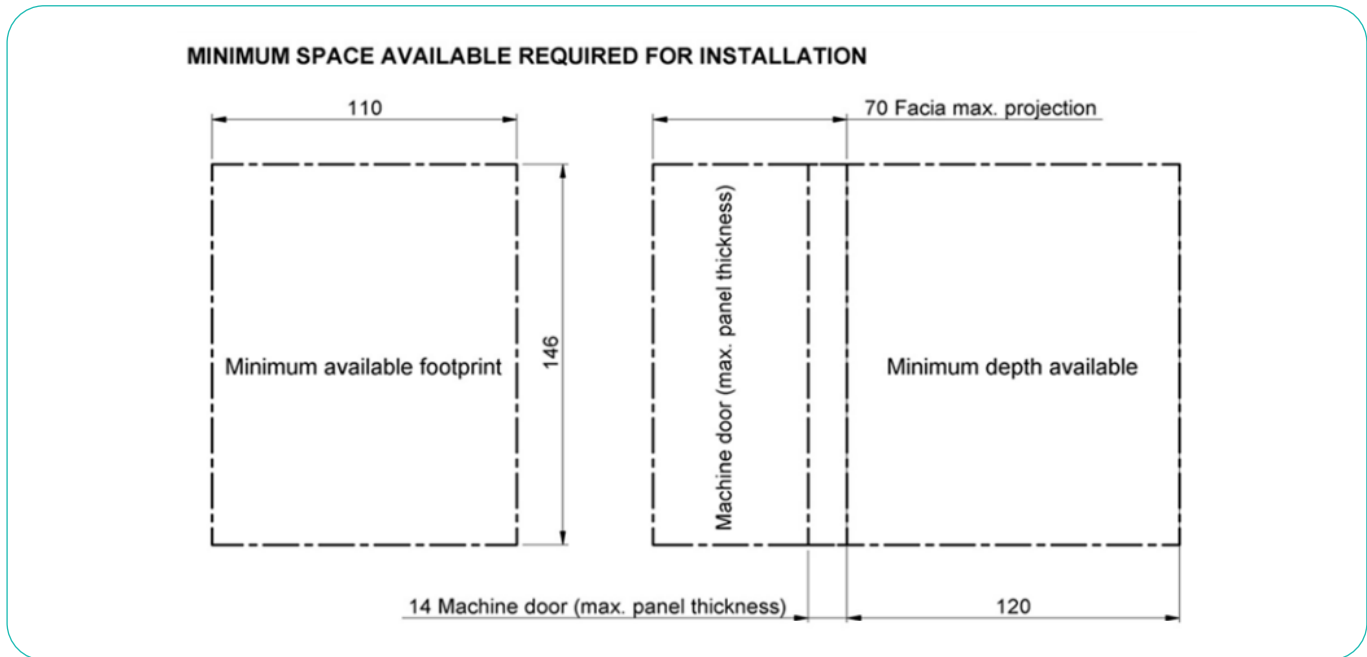

A standard mounting plate is delivered to mount the device in a panel of 3 mm or less. For panels > 3 mm thickness, a custom-made spacer needs to be used. These spacers will not be provided by Worldline.

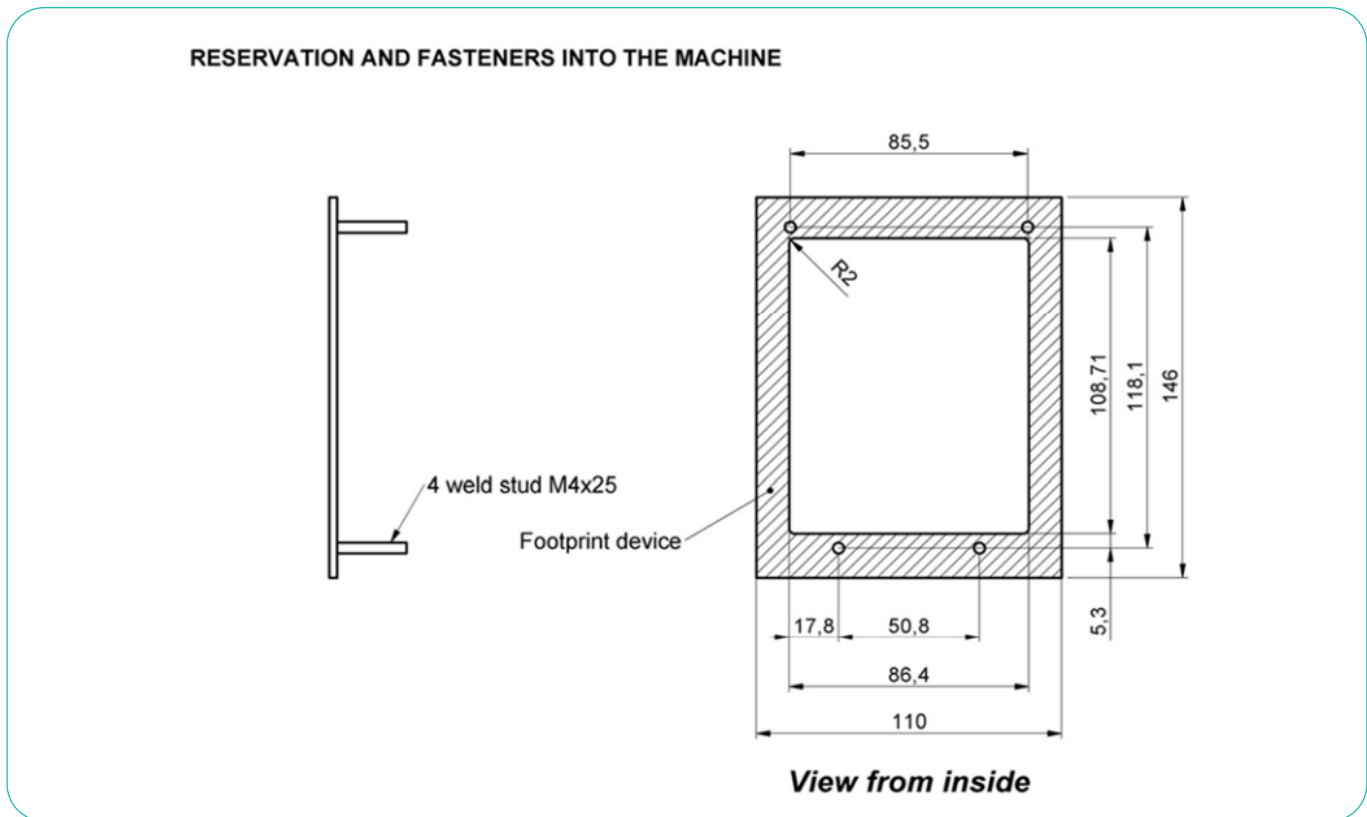

The dimensions are given in mm.

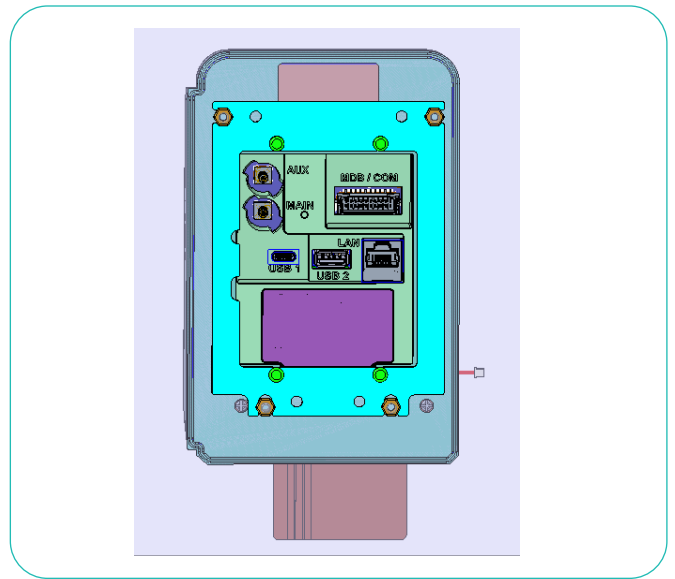
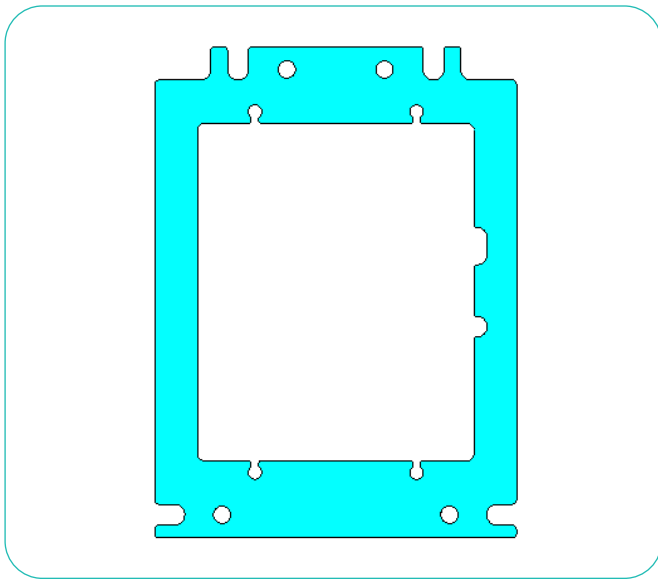

To ensure a watertight installation, it is important to use the silicon gasket and position it correctly between the terminal and the machine panel. Make sure that the panel is clean before positioning the terminal into its position. The terminal always needs to be positioned vertically from the ground.

#### Product gasket

To ensure the IP ratings, the gasket must be assembled correctly.

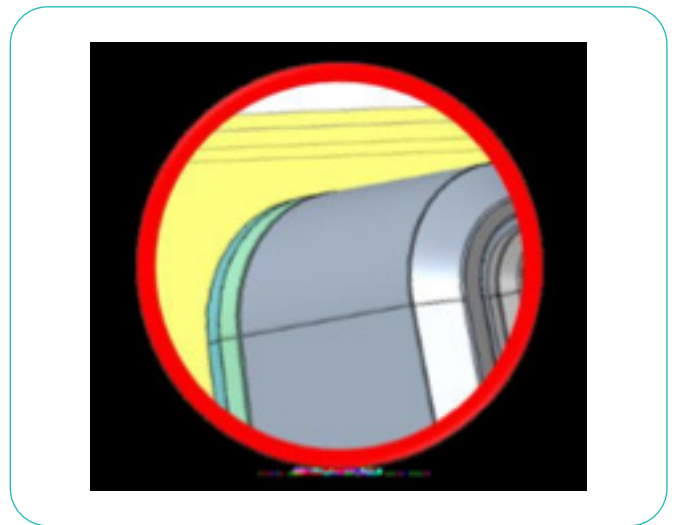
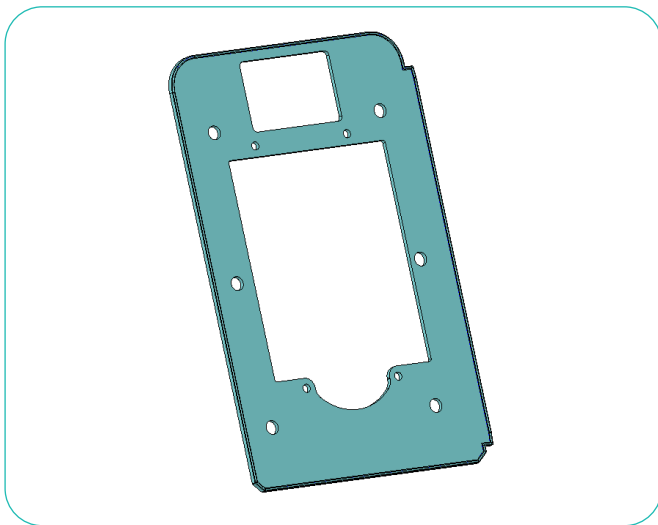

IP rating is related to front face only: S1U2 is IP65

#### Installation

##### Preparing the terminal

- Step 1: Make sure that the device is not powered.
- Step 2: Remove the plastic cover at rear bottom of the terminal
- Step 3: Insert the SIM when appropriate, please follow the described procedure above.
- Step 4: Put the cover back in place
- Step 5: Screw the two screws using torque:  
Fastener torque reference value  $3.5 \pm 0.3 \text{ kgf.m}$

##### Antenna mounting

- Step 1: Remove the antenna tool from the rest position
- Step 2: Screw the antenna on the relevant connector
- Step 3: Place the antenna tool again at the right position

### 2.6.5 S1U2 PRODUCT INSTALLATION

The label with PCI hardware version number must be visible from the inside once the device is installed.

The centreline of operating controls or input/output components must be at least 400 mm above the ground.

#### Caution

It is important that the device footprint surface on the kiosk must be flat and cleared of any holes and burrs to prevent from dust and water penetration into the kiosk (IP65 standard). Rubber at the rear of the product guarantees waterproofness between the EVA plate and the product. Waterproofness between the EVA plate and the kiosk panel should be guaranteed by the rubber on the EVA plate.

### 2.6.6 INSTALLING THE ALL-IN-ONE TERMINAL

If you are going to install a 4G comm-box board and antenna, prepare the vending machine first.

If you are going to install a SIM card or 4G comms board, complete this task before installing the comm-box on the terminal and before mounting the terminal in the vending machine.

#### Step 1: Check the gasket positioning

Lugs (pins) in the rubber should fit into the terminal openings above and below.

#### Step 2: Mount the modular terminal in the vending machine

1. Line up the terminal with the front panel opening on the vending machine.
2. Clamp the EVA frame to the rigid front plate of the machine using four locknuts.  
**Note:** These locknuts are not included in the terminal package
3. Tighten the locknuts in a Z-pattern.  
A cut-out with the standard dimensions of the EVA EPS door module in the kiosk is required.  
Mount the terminal on the custom EVA plate using the nuts and the washers.  
Fixing must be done by 4 M4 × 17 welded studs. The device requires standard hexagonal nuts for integration into a kiosk. Torque value used: 1.0–1.3 Nm. It is recommended to use washers.

To avoid damage to the terminal, do not over-tighten the nuts. 1.0 - 1.3 Nm torque is recommended, depending on the material the front plate is made of.

#### Step 3: Cabling

After mounting the terminal into the vending machine, continue by connecting the communications cables.

#### Step 4: Powering the devices

Plug in the power plugs and wait for the terminal to be booted.

The S1U2 is compliant to the Standard Door Module dimensions of the European Vending Association.

# 3 Safety

Follow the guidelines in this manual when integrating the S1U2. Neither Worldline nor its supplier will bear any responsibility or costs for malfunctions, breakdowns or anomalies that may result from incorrect handling of the payment terminals. Worldline disclaims all liability if the instructions and precautions contained in this manual are not followed.

If you notice that any component blocks, does not fit, or shows any other malfunction, contact your vendor. Do not attempt to repair or modify the device in any way.

Use only accessories (power adapters, cables, etc.) provided by your vendor or by an approved source.

Make sure that the S1U2 terminal has completed the necessary steps to load the application and keys.

Security features are integrated in all levels of the S1U2 terminal design, from the external housing to the chipset at the heart of the terminal. Regular visual checks are essential to avoid fraud from the outside.

## 3.1 OPERATING SAFETY

Keep the S1U2 terminals away from extensive heat, fire, high voltage, radiation, shocks and abrasive chemicals.

To guarantee safe operation of the S1U2 terminal, make sure:

- The terminals are firmly fixed in the kiosk/vending machine and are correctly wired and powered
- The kiosk/vending machine on which the S1U2 terminals are mounted is protected from dust, strong sunlight, rain, wind and flying parts (e.g. stones thrown up by passing traffic)
- The operating temperature of the terminals remains between -20 °C and 65 °C

Always:

- Use only the power adaptor supplied or a power adaptor compliant with the appropriate specifications
- Disconnect the power adapter before cleaning the housing and before maintenance or repair work

Never:

- Drop, throw, slam or vibrate the terminals
- Let oil, water or other liquids enter the terminals
- Use extension cables to extend the power cable between the power adaptor and the S1U2 terminals
- Connect any unused cables to the S1U2 terminal
- Store, install or use the S1U2 terminal
  - Near any source of excessive voltage fluctuation, electromagnetic fields or microwave radiation (e.g. electric motors or high-frequency devices)
  - In a deep freeze or a defrosting system
- Store the S1U2 terminals near food, or near explosive substances such as lighter fuel or petrol
- Open the S1U2 terminals

## 3.2 SAFETY RECOMMENDATIONS

### 3.2.1 INTEGRATORS

Integrators must implement appropriate procedures to ensure that each installation is regularly checked on site. These checks are to ensure that:

- No camera has been set up to track cardholder activity
- No skimming device has been installed
- No foreign objects are present in any of the card-readers

If anything suspicious is found in the chipcard reader or if the S1U2 terminals are displaying a "tampered" warning message, the integrator must:

- Disconnect the terminal from the power source
- Alert the police or computer crime unit and provide them with all requested elements for investigation
- Alert the acquirer with precise details of the location and situation
- Alter the regulator (eg CB, ep2) if appropriate

Partners are fully responsible for the integration of each S1U2 into their kiosk and must comply with:

- (i) the local standards and regulations;
- (ii) the integration rules set out in this guide;
- (iii) the state of technology and current industry practices in terminal design, manufacture, integration, commissioning and maintenance.

Worldline cannot be held responsible for any S1U2 integration that does not meet the criteria described.

The S1U2 is designed to comply with the applicable international and/or local standards, particularly in environmental (CE, RCM, etc.) and security (EMV, PCI, etc.) terms. Documents confirming compliance with these standards can be made available on request.

The partner is responsible for the complete assembly of the terminal, which comprise other third-party components, materials and solutions as well as the cashless payment solution. Before assembling the terminal, the partner must undergo subsequent checks in accordance with the local, European and/or international legislation/regulations applicable (hereinafter the "**certification(s)**"). For example, with regard to electromagnetic compatibility.

**For the European Union:** Commissioning and market release of the terminals is subject to the receipt of the CE declaration of compliance in accordance with Directive 2004/108/EC of 15 December 2004.

### 3.2.2 MERCHANTS

For security reasons, merchants are advised to check their S1U2 terminals every working day and make sure that:

- There are no signs that any unusual cables are connected anywhere on the terminal
- There are no foreign objects in any of the card readers

- The terminal does not display warning messages
- There is no visible damage to the housing
- The serial number of the terminal (label) matches the inventory

### 3.3 EC MARKING

EC standard compliance marking certifies that the product conforms to the following harmonised standards:

Audio/video, information and communication technology equipment – Part 1: Safety requirements IEC/EN 62368-1: 2014

RE Directive 2014/53/EU. The Radio Equipment Directive

Radio: ETSI EN 300 330-1 V2.1.1 – Electromagnetic compatibility and Radio spectrum Matters (ERM); Short Range Devices (SRD)

EMC: ETSI EN 301 489-1 V2.1.1, ETSI EN 301 489-3 V2.1.1 – Electromagnetic compatibility and Radio spectrum Matters (ERM); Electro Magnetic (EMC) standard for radio equipment and services.

### 3.4 REPAIRS AND END OF LIFE

Any maintenance and actions beyond what is described in this manual must be carried out by Worldline or an approved service centre. Contact your vendor for information on how to dispose of your S1U2 terminals at the end of their lives. Do not discard, give away or sell your S1U2 terminals as they contain materials that cannot be recycled and must be handled by a professional party.

#### Environment (WEEE, batteries and packaging)

The products are labelled in accordance with European Directives 2012/19/EU concerning Waste Electrical and Electronic Equipment (WEEE) and 2006/66/EC regarding batteries and accumulators. These provisions stipulate that producers and manufacturers are liable for the take-back, treatment and recycling of equipment and batteries upon end of life.



The associated symbol means that WEEE and waste batteries must not be thrown away but collected separately and recycled.

We ensure that efficient collection and recycling schemes are set-up for WEEE and batteries according to the local regulation of your country.

Packaging waste must also be collected separately to guarantee a proper disposal and recycling.

Please note that proper recycling of the electrical and electronic equipment and waste batteries will ensure safety of human health and environment.